

**G A M E  R E A D Y™**

**CONTROL UNIT**

**User's Manual**

**MODEL 500055**

**GAME READY CONTROL UNIT**

**MODEL 550350**

**PRE-PROGRAMMED CONTROL UNIT**

## T H E G A M E R E A D Y D I F F E R E N C E

Game Ready™ was built upon the concept that the principles behind spacesuit technology could be used to develop an injury treatment system. As a designer for NASA and an inductee into the U.S. Space Foundation's Hall of Fame, our founder helped pioneer the technology involved in controlling pressure and temperature within a flexible garment. In 1998, we began working with athletes, athletic trainers, doctors, and engineers to expand breakthrough discoveries into the realm of sports medicine.

## I N D I C A T I O N S F O R U S E

The Game Ready System combines cold and compression therapies. It is intended to treat post-surgical and acute injuries to reduce edema, swelling, and pain where cold and compression are indicated. It is intended to be used by or on the order of healthcare professionals in hospitals, outpatient clinics, athletic training settings, or home settings.

## R E G I S T E R Y O U R P R O D U C T

Please complete and return the Warranty Registration cards for both the Game Ready Control Unit and the Wraps. The Control Unit registration card is located behind the front cover of this manual, and the Wrap registration card is packaged with the heat exchanger of each Wrap. You may also go to [www.gameready.com](http://www.gameready.com) to register your product. You must register within 30 days from the date of purchase in order to receive warranty service.

Let us know what you think of our products. We'd love to hear from you.

Game Ready  
CoolSystems Inc.  
2201 Dwight Way  
Berkeley, CA 94704

**Toll-free phone number:**  
**1.888.GameReady**  
**1.888.426.3732**

[www.gameready.com](http://www.gameready.com)



# TABLE OF CONTENTS

<b>INDICATIONS FOR USE</b>	1
<b>CONTRAINDICATIONS</b>	4
<b>GENERAL WARNINGS AND PRECAUTIONS</b>	4
<b>THE GAME READY SYSTEM</b>	
Your Game Ready System	7
Control Panel/Basic Controls	8
Priming a New Wrap	8
Control Unit Set Up	9
Wearing the Wraps	10
<b>IMPORTANT USER GUIDELINES</b>	11
<b>GETTING STARTED</b>	12
<b>ADJUSTING SYSTEM SETTINGS</b>	14
<b>OPERATING THE SYSTEM IN THE BAG</b>	15
<b>POWERING THE SYSTEM</b>	15
<b>CARE AND STORAGE</b>	
Cleaning, Storage and Transportation	16
Cleaning and Replacing the Filter	16
Wrap Care and Storage	17
<b>TROUBLESHOOTING</b>	18
<b>WARRANTY INFORMATION: CONTROL UNIT</b>	21
<b>PRODUCT SPECIFICATIONS</b>	Back Cover
<b>HOW TO CONTACT US</b>	Back Cover
<b>WARRANTY REGISTRATION CARDS</b>	Inside Front Cover Pocket

## C O N T R A I N D I C A T I O N S

- Compression Therapy (vasopneumatic compression) using Game Ready or any compression therapy device should **not** be used in patients:
  - Who are in the acute stages of inflammatory phlebitis in the affected region
  - Who have any history or risk factors for deep vein thrombosis or pulmonary embolus (including prolonged bed rest) in the affected region (to be treated with this therapy)
  - Who have a cardiac insufficiency or congestive heart failure (with associated edema in the extremities or lungs)
  - Who have significant arteriosclerosis or other vascular ischemic disease in the affected region
  - Who have a localized skin condition (eg, dermatitis, vein ligation, gangrene, skin graft) in the affected region
  - Who have a condition in which increased venous or lymphatic return is not desired in the affected extremity (eg, carcinoma)
  - Who have erysipelas or other active infection in the affected region
  - Who have decompensated hypertension in the affected region
- Cryotherapy using Game Ready or any cryotherapy device should **not** be used in patients:
  - Who have significant vascular impairment in the affected region (eg, from prior frostbite, diabetes, arteriosclerosis or ischemia)
  - Who have acute paroxysmal cold hemoglobinuria or cryoglobulinemia

## G E N E R A L W A R N I N G S A N D P R E C A U T I O N S

Thank you for choosing the Game Ready System. To assure you have the best experience possible, please be sure to read the entire User's Manual prior to use of the product.

**Caution: Federal Law restricts this device to sale by or on the order of a licensed health care practitioner.**

### WARNINGS

- **Improper placement or prolonged use of Game Ready could result in tissue damage such as frostbite.**
- During the course of Game Ready therapy, patients should monitor the skin surrounding the treated region or the digits of the extremities of the treated limb for any burning, itching, increased swelling, or pain. If any of these signs present, or any changes in skin appearance occur (such as blisters, increased redness, discoloration, or other noticeable skin changes), patients are advised to discontinue use and consult a physician.
- The Game Ready Wrap is not sterile; do not place directly against open wounds, sores, rashes, infections, or stitches. May be applied over clothing or dressing.
- Compression Therapy (vasopneumatic compression) with the Game Ready System should be used **only under the supervision** of a licensed healthcare practitioner in patients:
  - Who have a wound in the affected region (the wound must be dressed prior to use of Game Ready)
  - Who have an acute, unstable (untreated) fracture in the affected region
- Cryotherapy with the Game Ready System should be used **only under the supervision** of a licensed healthcare practitioner in patients:
  - Who have Raynaud's disease or cold hypersensitivity (cold urticaria)
  - Who have hypertension or extreme low blood pressure
  - Who have diabetes
  - Who have compromised local circulation or neurologic impairment (including paralysis or localized compromise due to multiple surgical procedures) in the affected region
  - Who are children or who have cognitive disabilities or communication barriers
  - Who have rheumatoid arthritis in the affected region
  - Who have known and un-controlled peptic ulcer (if the affected region is the abdominal region) since cold therapy applied to the abdomen can cause increased gastrointestinal motility and gastric acid secretion

## WARNINGS CONT.

- You should not operate a vehicle or heavy machinery while using the Game Ready System.
- To avoid the risk of electrical shock, do not remove any panels from the Control Unit. Refer all servicing and repair to Game Ready Customer Service at 1.888.426.3732. Opening the case will void the Game Ready warranty.
- Never operate the System with damaged power line cords or connector hoses.
- Always turn off the System and disconnect the power line cord from its electrical outlet when not in use or before adding ice and water.
- Do not use any adapter other than that provided by Game Ready. Use of other adapters may result in electrical shock and will void the Game Ready warranty.
- Be careful not to trip over the System's power cords and connector hose.
- Be mindful of the power cords and connector hoses to avoid any risk of strangulation.

## PRECAUTIONS

- Do not operate the System without any water in the ice box.
- Do not pour hot water into the ice box.
- Do not pick up the Control Unit by the lid. Carry using the handle only.
- Do not use any wraps designed by other manufacturers with the Game Ready System.
- The Game Ready Control Unit is a technical medical device. **Handle it with the same care as you would a laptop computer.** Do not drop it, kick it or otherwise abuse it unnecessarily. Such abuse will void all Game Ready warranties.

In addition to the precautions listed above, additional warnings and safety precautions are posted throughout this manual. Read and carefully follow these instructions prior to operating the System.

# UL SAFETY CLASSIFICATION INFORMATION

## 1. Protection against electric shock (5.1)

The Game Ready power supply (Ault Model MW128) is considered to be Class I (grounded) equipment.

The Game Ready power supply (GlobTek Model GTM21097-5012) is considered to be Class II (ungrounded) equipment.

## 2. Protection against harmful ingress of water (5.3)

This product provides ordinary protection against ingress of water. The Game Ready system is considered to be Class I (ungrounded) when connected to the Ault Model MW128 power supply, and Class II (ungrounded) when connected to the GlobTek Model GTM21097-5012 power supply.

## 3. Degree of safety in the presence of flammable anesthetics or oxygen (5.5)





Not suitable for use in an oxygen enriched environment or in the presence of flammable anesthetics.

## 4. Mode of operation (5.6)

The equipment operates under continuous operation and continuous operation with intermittent loading if operating the system continuously without a full load of ice. Users should allow the system to rest for at least 15 minutes between each 90-minute treatment.

## 5. Electromagnetic Interference:

This equipment has been tested and found to comply with the limits for medical devices in IEC 60601-1-2:1994. These limits are designed to provide reasonable protection against harmful interference in a typical medical installation. This equipment generates, uses and can radiate radio frequency energy and, if not installed and used in accordance with the instructions, may cause harmful interference to other devices in the vicinity. However, there is no guarantee that interference will not occur in a particular installation. If this equipment does cause harmful interference to other devices, which can be determined by turning the equipment off and on, the user is encouraged to try to correct the interference by one or more of the following measures: reorient or relocate the receiving device, increase the separation between the equipment, connect the equipment into an outlet on a circuit different from that to which the other device(s) are connected, consult the manufacturer or field service technician for help.

	<p>Medical Equipment With respect to electrical shock, fire, and mechanical hazards only in accordance with UL 60601-1, CAN/CSA C22.2 No. 601.1 &lt;61ZJ&gt;</p>
	<p>Powered by Direct Current</p>
	<p>Type B Applied Parts</p>
	<p>Attention: Consult accompanying documents before use</p>
	<p>Manufacturer</p>

## YOUR GAME READY SYSTEM

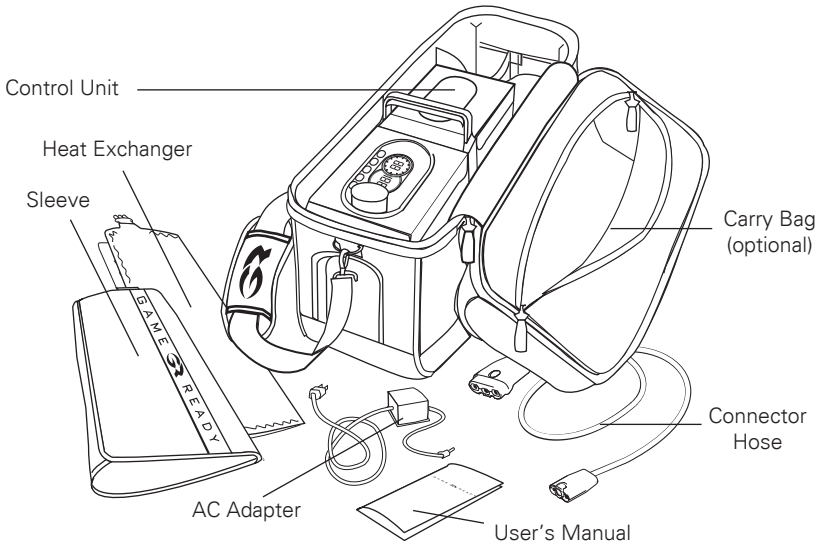

## CONTROL UNIT ORIENTATIONS

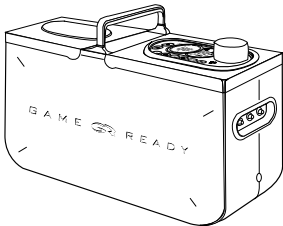

Figure A: Upright

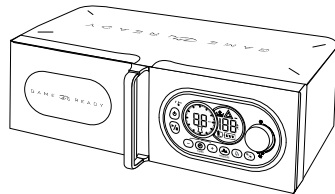

Figure B: Side

The Control Unit can sit upright (Fig. A) or on one side (Fig. B) to fit on a shelf.

**Caution:** Do not put the unit on the side where the control panel is upside down. This will cause the unit to leak water.

**Note:** The Wrap is comprised of an inner heat exchanger and an outer sleeve. The combination of sleeve and heat exchanger is referred to throughout this manual as a "Wrap."



## CONTROL PANEL / BASIC CONTROLS

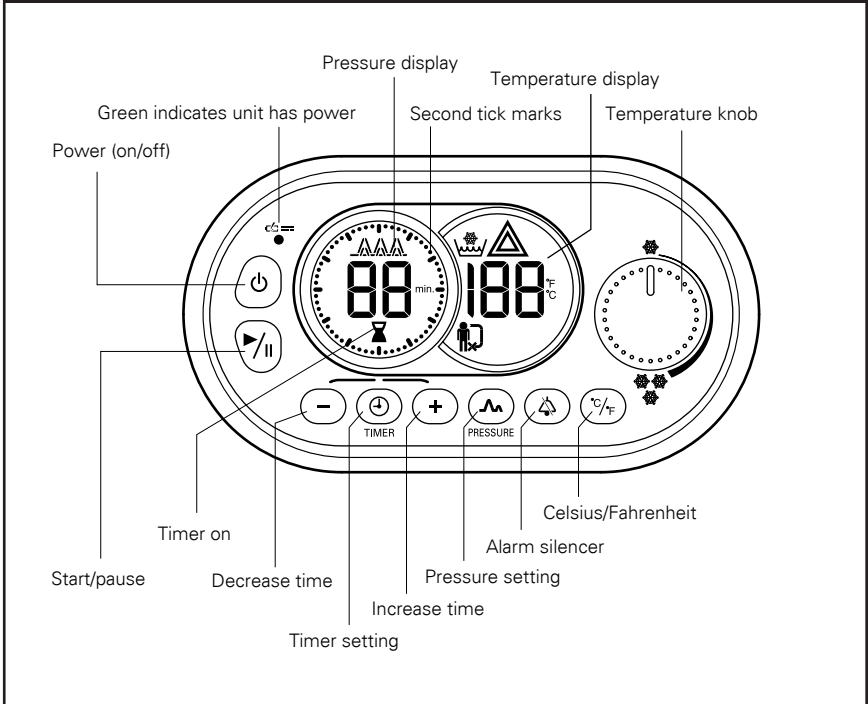

## PRIMING A NEW WRAP OR COOLING VEST

A brand new Wrap or Cooling Vest should first be filled with water ("primed") before it is used. To prime a new Wrap or Vest, follow the Quick Set Up Instructions and then the following:

1. Connect Wrap or Vest to Control Unit (Wrap or Vest need not be worn to prime).
2. Press the pressure button on the control panel to set the pressure on "no pressure".
3. Turn the temperature control knob to maximum cold (3 snowflakes).
4. Press the start button.
5. Run for a minimum of two minutes.

**Note:** Often when priming a larger Wrap or vest, the Control Unit alarm will sound after 45 seconds, the low flow icon will flash and the Control Unit will stop. This is because there isn't enough water returning to the Control Unit, due to the new Wrap being filled. To continue, simply restart the priming process following the steps above. After 2 minutes the Wrap or Vest is fully primed and ready to be used. Repeat the steps above for each additional new Wrap or Vest.

## CONTROL UNIT SET UP

### Filling the Ice Box

Stand unit upright. Then unplug the unit from the electrical outlet. To open the ice box lid, pull up on the latch on the end panel of the Control Unit. Fill the ice box with as much ice as possible. For maximum cooling duration, use cubed ice. Pour water over the ice to one-half inch below the rim. **Dry off the rubber gasket** to ensure a good seal. Close the lid securely and lock it into place by pulling down on the latch.

**Note:** The system provides cooling to the Wrap on less ice but we recommend you fill the ice box completely.

**Caution:** Do not pour hot water into the ice box.

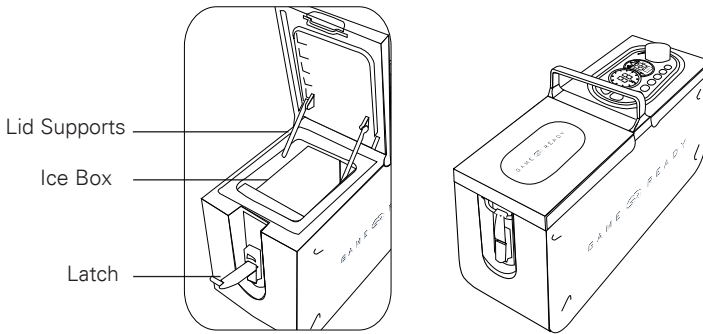

**Refilling the ice box:** Once the unit has been operating for more than an hour, check the ice box. If little or no ice remains, then refill the ice box to assure maximum cooling. If the unit is turned on its side, place it back in its upright position before opening the ice box lid by pulling up on the latch. Press the power button to turn off the unit. Unplug the unit from the AC adapter and empty excess water from ice box. Fill the ice box with as much ice as possible. Pour water over the ice to one-half inch below the rim. Close the lid securely and resume therapy.

**Note:** Ice can be added to the Control Unit while it is running (as long as it is standing upright).

### Connecting the Wrap to the Control Unit

The connector snaps easily into place on the end panel of the Control Unit. When inserted correctly, the disconnect button will be on top. To disconnect, simply press the button and remove the connector from its port. When disconnecting the Connector Hose from the Control Unit, it is normal for a few drops of water to drip from the Connector Hose nozzle. Be sure not to hold the button down while connecting the Wrap to the Control Unit.

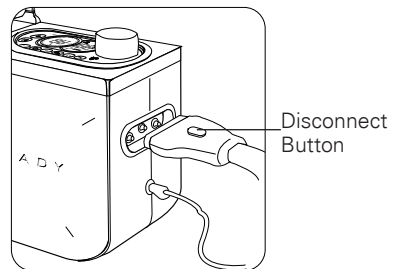

## WEARING THE WRAPS

### WARNINGS

- If used incorrectly, **cold therapy can cause frostbite or other tissue damage.**
- During the course of Game Ready therapy, patients should monitor the skin surrounding the treated region or the digits of the extremities of the treated limb for any burning, itching, increased swelling, or pain. If any of these signs present, or any changes in skin appearance occur (such as blisters, increased redness, discoloration, or other noticeable skin changes), patients are advised to discontinue use and consult a physician.
- The Game Ready Wrap is not sterile; do not place directly against open wounds, sores, rashes, infections, or stitches. May be applied over clothing or dressing.

### For more information on a specific Wrap, see the Use Guide packaged with the sleeve.

After fastening the Wrap on yourself or another person, connect the Wrap to the Control Unit. Press the power button. Adjust the timer, pressure, and temperature settings.

After treatment, remove the Wrap from yourself/patient and disconnect from the Control Unit.

**Caution:** If applying the same Wrap to another person make sure the Wrap is deflated before the next application.

### Connecting The Hose To The Wrap

**Note:** To ensure the Connector seals properly make sure that both the Wrap and Connector Hose halves are lined up straight when they are pushed together.



## IMPORTANT USER GUIDELINES

The Game Ready System provides intermittent compression and adjustable cold therapy by controlling fluid flow and air pressure. The Control Unit software is designed to protect both the user and the Control Unit from harm by shutting off the System and sounding an alarm if there is insufficient fluid flow or an over-pressure or under-pressure situation. To help prevent fluid flow or air pressure issues with the Control Unit please follow these guidelines:





**Fluid Flow:** Like any other fluid system, a reduction in fluid flow can happen because of a blockage somewhere in the fluid path (like kinking your garden hose). There are five ways to manage the fluid flow to prevent a blockage in the fluid path:

- 1. Temperature Setting:** Always start your Game Ready System on the coldest temperature setting (3 snowflakes) and run it that way for a minimum of 2 minutes before adjusting the temperature as necessary.
- 2. Wrap Application:** When applying the Wraps, avoid major folds or creases in the Wrap. The Wraps are designed to bend around the body, but if a Wrap has a big crease or fold, then the fluid flow can be sufficiently reduced to cause a system shutdown. The Shoulder Wrap in particular needs to be applied correctly so that there is not a large crease at the tip of the shoulder.
- 3. Switching a Wrap:** If you take a Wrap off one user and immediately apply it to another user, be sure that the air bladder of the Wrap is completely deflated before starting treatment on the new user. To deflate the Wrap, simply unplug the Wrap from the Control Unit and squeeze the excess air out.
- 4. Connector Hose:** To assure proper connection, make sure the connector hose is securely pushed into the Wrap. Do not let the Connector Hose fold over or coil unto itself when in operation, this could cause a fluid flow error. Avoid kinking the hose at any point along its length.
- 5. Ice Box:** If you're using shaved or finely crushed ice, avoid packing it too tightly, as it can partially clog the filter and reduce fluid flow enough to cause a system shutdown.

**Air Pressure:** When operating on low, medium or high pressure, the Game Ready Control Unit is designed to alert the user if it does not achieve its minimum or maximum pressure requirements. It's possible for the user to make the Control Unit "think" it's over-pressuring or under-pressuring by exerting pressure on the outside of the Wrap while the system is running. This will cause the Unit to shut down, sound the alarm and display a PH, OP, UP error on the display (See page 18 for details). To help prevent this from happening, do the following:

Avoid exerting sporadic pressure on the exterior of the Wrap. It is fine to lie on the Wrap or lean against a chair with a Wrap on, as long as you maintain that position. If you move around with a Wrap on, while the Control Unit is attempting to reach pressure, there is a good chance the Control Unit will shut down and sound the alarm. If you want to move around while wearing the Wrap, run the System without pressure.

## GETTING STARTED

1. Pull up the latch to open the ice box lid. Fill the Control Unit with as much ice as possible and water, to 1" from the lip of the ice box. Close the lid securely.
2. Connect the AC adapter to the Control Unit, then plug it into an electrical outlet.
3. Apply the Wrap to the injured area and secure.
4. Attach the Connector Hose first to the Wrap, then to the Control Unit.
5. Press the Power  button.
6. If you have a **Standard Unit**, press the Pressure  and Time  Buttons to adjust the pressure and time settings.  
If you have a **Pre-Programmed Unit**, the system will default to Pre-Set Program 1, which will run for 30 minutes, then will turn off (sleep) for 30 minutes at no compression. Each Program will continue the pre-set 30/30 on/off cycle indefinitely. Press the Timer  button to scroll through the Programs:

### Pre-Set Program 1

30 minutes on with  
**no** pressure,  
30 minutes in sleep mode

 30/30/No Pressure

### Pre-Set Program 2

30 minutes on with  
**low** pressure,  
30 minutes in sleep mode

 30/30/Low Pressure

### Pre-set Program 3

30 minutes on with  
**medium** pressure,  
30 minutes in sleep mode

 30/30/Med Pressure

If you press the timer button once, you will be in Pre-Set Program 2, and if you press the timer button twice, you will be in Pre-Set Program 3. **Please Note:** If you press the timer button three times, you will be in Manual Mode. The Control Unit will be set for a 15 minute treatment at low compression. You can select the pressure and time settings to adjust your treatment. Press the timer button once more to toggle through the elapsed time setting. One more press of the timer button will bring you back to Pre-Set Program 1.

7. Start with the temperature knob turned to maximum cold (3 Snowflakes). Adjust the temperature as necessary. Select pressure and time settings.
8. Press the Start  button.

## CONTROL PANEL

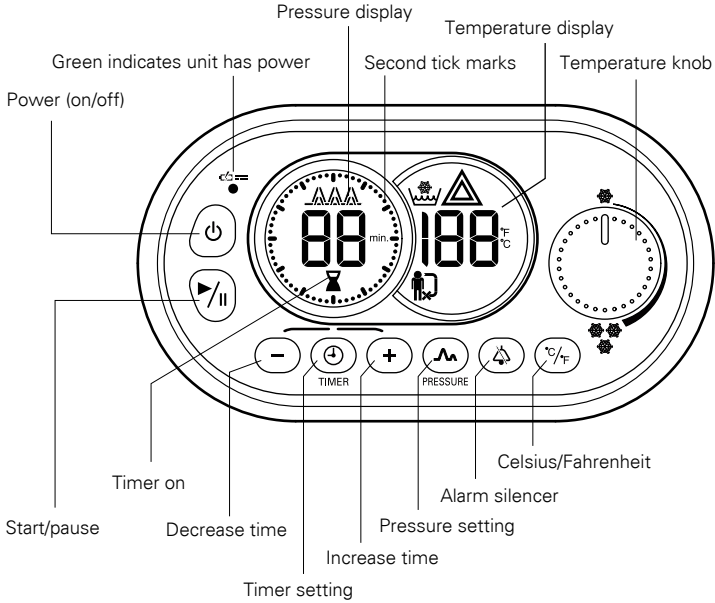

## PRESSURE SETTINGS

No pressure	Low 5-15 mmHg	Medium 5-50 mmHg	High 5-75 mmHg	

## PRE-SET PROGRAM DISPLAY (For Pre-Programmed Control Units Only)

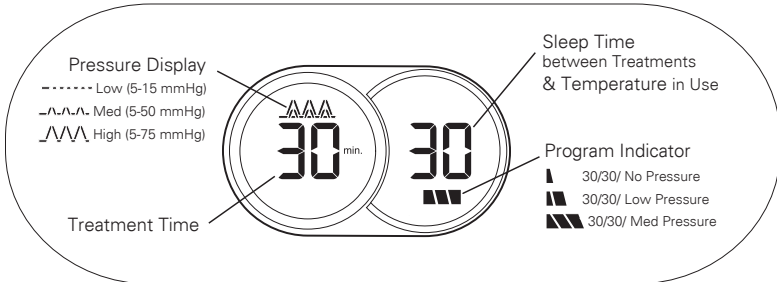

## ADJUSTING SYSTEM SETTINGS

### ADJUSTING PRESSURE

Press the pressure button on the control panel to adjust the level of compression.

The system has four pressure options: **1. No pressure:** circulates the ice water only, **2. Low pressure:** inflates and deflates the Wrap from 5-15 mm Hg over approximately a 5 minute cycle, **3. Medium pressure:** inflates and deflates the Wrap from 5-50 mm Hg over approximately a 3 minute cycle, or **4. High pressure:** inflates and deflates the Wrap from 5-75 mm Hg over approximately a 3 minute cycle.

The appropriate pressure icon will flash as the unit cycles pressure. The left-hand side of the icon will appear and flash as the pressure cycles up, and then the right-hand side will appear and flash as the pressure cycles down. Large Wraps, such as the Knee Wrap, will have longer pressure cycles than smaller Wraps, such as the Ankle. The system will default to the low pressure mode for all Wraps. To adjust the pressure, press once for medium pressure, twice for high pressure and three times for no pressure. If you press pause for any reason, such as to switch Wraps, the pressure will remain in its previously selected mode until you press the pressure setting button to adjust. Only by turning the system off will it reset to the default pressure mode.

**Note:** If you have a Pre-Programmed Unit, the system will default to Pre-Set Program 1 (no compression). You can press the Timer button to select an alternate program or to access Manual Mode, where you can adjust pressure and time settings.

**Warning:** The Cooling Vest should only be operated on no pressure or low pressure. Do not operate the Cooling Vest on medium or high pressure.

#### Changing Pressure During Treatment

The pressure cannot be adjusted while the system is in use. To adjust the pressure, press the pause button, change the pressure to the desired mode, and then press the start button to resume therapy.

### ADJUSTING TEMPERATURE

Press the °C/°F button to choose your desired mode. By turning the temperature knob, you can adjust the amount of ice water being pumped through the Wrap. Turn the knob towards the three snowflakes for colder or towards the one snowflake for warmer. With a full ice box, typically the Control Unit will provide cold therapy between 35 °F and 50 °F.

### SETTING TREATMENT TIME

Each time the power button is used to turn the system on, the hourglass icon will appear and the timer will automatically set for 15 minutes. If you press start, the system will run for 15 minutes, then stop. Adjust the length of a timed session by pressing the plus or minus keys to your desired time, from 0-95 minutes, in 5 minute increments. Once you've set the desired treatment time, press the start button. An hourglass icon will appear on the control panel to indicate the timer is running. When the time is up, the alarm will beep and the system will stop.

#### Changing Timer During Treatment

To add or subtract minutes while the timer is running, you must first press pause, then press the plus or minus buttons. (If you press the timer setting button or the plus or minus buttons while the system is in use, the system will not respond.)

#### Running The System Continuously

If you'd rather run the system continuously, just press the timer button once, the display will change to zero, and the hourglass icon will disappear. Press start and the system will run and begin counting elapsed time. The system will run for a maximum of 190 minutes, by counting up to 95 minutes and then back down to zero. After 190 minutes, the system will stop and remain in pause mode.

## OPERATING THE SYSTEM IN THE BAG

To operate the Game Ready System, you don't need to remove it from the bag. Simply unzip the bag's main compartment and end panel. To fill with ice and water, open the ice box lid. Attach the Connector Hose and the AC adapter to the end panel of the Control Unit. Plug the AC adapter into an electrical outlet. When finished with the therapy session, unplug the AC adapter from the electrical outlet. Disconnect the Connector Hose and the AC adapter from the end panel of the Control Unit. Remove the Control Unit from the bag to empty the ice box.

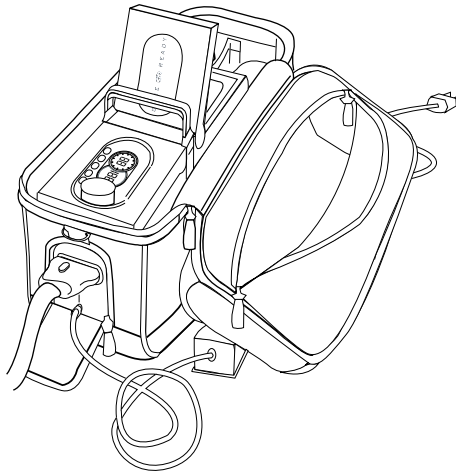

## POWERING THE SYSTEM

### How to Use the AC Adapter

The Game Ready System operates using external power through the AC adapter. Connect the AC adapter to the Control Unit and plug the other end into an electrical outlet. The system operates on AC line input 120V/60Hz or 240V/50Hz. Use caution when handling your AC adapter. Do not put it in water.

**Warning:** Do not use any adapter other than that provided by Game Ready (Ault Model MW128 or GlobTek Model GTM21097-5012). Use of other adapters may result in electrical shock and/or damage to the Control Unit and void your warranty.

**Note:** If you will be using the Game Ready System with a Game Ready supplied battery pack, please consult the instructions for use that accompanied that battery pack for usage details.



## CARE AND STORAGE

### Cleaning

The Game Ready System is a valuable part of your therapy equipment. Please handle the Control Unit as you would a laptop computer. When you are finished using the system for the day, unplug the Control Unit from the electrical outlet. Disconnect both the Wrap and AC adapter from the Control Unit. Empty the water and ice from the ice box. The interior of the ice box should be cleaned once every three months. To clean the exterior of the Control Unit, simply wipe with a soft cloth rinsed in warm water and a mild disinfectant containing any of the following agents:

- A. Mild detergent
- B. Lysol
- C. Rubbing alcohol (off the shelf)

To clean the internal fluid circuit of the Control Unit fill the ice box 3-4 inches deep with hydrogen peroxide (2%), attach any Wrap and run the unit for 2 minutes.

**Caution:** Leave the lid open when using hydrogen peroxide.

### Storage and Transportation

Storage Temperature Conditions: 1° - 50° C (33° - 122° F).

Relative Humidity: 10% - 95% non-condensing.

Store the Game Ready System in the carrying case or on a shelf, preferably with the lid open to allow the interior to dry.

**Caution:** Do not keep in extreme hot or cold temperatures (above 120°F or below 33°F). Avoid leaving in the trunk of a hot or freezing car.

### Cleaning and Replacing the Filter

Your Game Ready unit is equipped with a special filter designed to keep dirt and debris out of the fluid system. To assure consistent flow of water through the system, the filter should be checked and cleaned every three months of regular use.

**Caution:** If the filter becomes clogged, the Control Unit alarm will beep, the "low flow" icon will flash, and the unit will go into pause mode. Check to be sure the filter is not clogged.

In addition to cleaning the filter every three months, it should be replaced after one year of regular usage. Call us toll-free at 1.888.GameReady for a free replacement filter.

#### To clean or replace the filter, follow these steps:

1. Turn off power and unplug the system from its electrical outlet.
2. With the Control Unit in the upright position, open the ice box door.
3. Empty any water and ice in the ice box.
4. Locate the filter inside the ice box with your hand, as shown in Fig. A.
5. Press the silver metal button on top of the filter, as shown in Fig. B. You should hear a click as the filter is released.
6. Pull the filter straight out from its housing (Note: The release button is part of the housing and therefore remains attached to the inside of the unit).
7. Clean the filter by rinsing it thoroughly under warm running water. Shake it a few times to clear out any remaining debris.
8. Re-insert the filter in the unit by reaching in and snapping it back into the housing. You should hear it click into place.

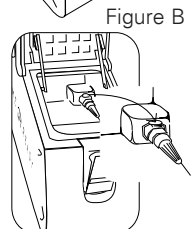
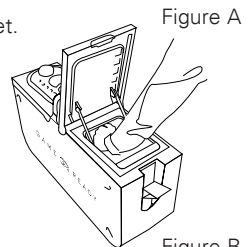

## Wrap Care

See Wrap Use Guide for instructions on how to clean the exterior of the Wraps.

The **interior** of the Wrap can be cleaned once a month by emptying 2-3 bottles of 16-24 oz. hydrogen peroxide (2%) into the ice box of the Control Unit and running the system for five minutes. Fill the ice box approximately four inches deep with hydrogen peroxide. Leave the ice box lid open. Adjust the pressure setting to the “no pressure” mode. Adjust the temperature to its coldest setting (3 snowflakes). Set the timer for five minutes and press the start button.

**Caution:** Leave the ice box lid open when using hydrogen peroxide to clean the interior of the Wrap. If the ice box is sealed shut, hydrogen peroxide can form a gas that could build excess pressure inside the unit and potentially damage the system.

## Wrap Storage

Do not store Wraps in extreme cold temperatures (below 33F). To store, coil the Connector Hose, and fold the Wrap neatly on its natural folds. Handle your Wraps with care.

**Caution:** Do not store Wraps inside a plastic bag or other airtight container as it may promote mold growth.

## Bag Care and Storage

Wipe clean with mild soap and water, air dry.

**Caution:** Store the Game Ready System out of the reach of children and pets.

## HOW TO PACK THE GAME READY SYSTEM

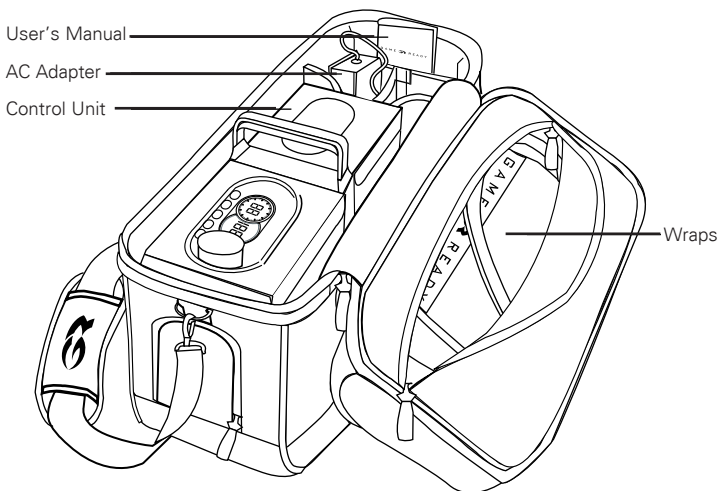



## TROUBLESHOOTING

**Soft Error:** When a Soft Error occurs, the system will continue to run, and will not fully shut down. Therapy can continue even though the optimal levels are not being reached.

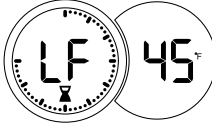
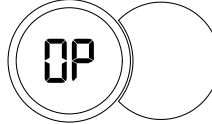
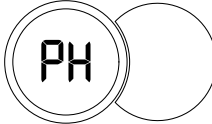
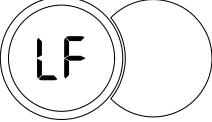
**Hard Error:** When a Hard Error occurs, the system will shut itself down and will require attention to start therapy again.

ERROR SCREEN	WHAT DOES IT MEAN?	WHAT SHOULD I DO?
 <p style="text-align: center;"><b>Soft Error</b></p>	<p><b>Under Pressure:</b> The Control Unit can't reach its target maximum compression. This often indicates that there is a leak in the pneumatic compression circuit, either in the Connector Hose or the Wrap itself. This is a Soft Error. There is no danger to the person being treated or the Control Unit, and therapy will continue.</p>	<p>Once treatment has finished, try the same pressure with a different Wrap, if one is available. When you have determined if the problem is isolated to one Wrap or not, call Game Ready customer service at 1.888.GameReady (426.3732). You can continue to use your system without harming the Control Unit. You can even continue using the affected Wrap, but this error will persist.</p>
 <p style="text-align: center;"><b>Soft Error</b></p>	<p><b>Low Flow Warning:</b> The Control Unit has detected a temporary interruption of fluid flow, but it was able to correct the situation by reducing the compression setting. This is a Soft Error. There is no danger to the person being treated or the Control Unit, and therapy will continue.</p>	<p>This error can often be corrected by reapplying the Wrap so that it is snug against the body part being treated. Please consult your Wrap Use Guide for more detailed instruction. If the problem persists, call customer service at 1.888.GameReady (426.3732).</p>
 <p style="text-align: center;"><b>Hard Error</b></p>	<p><b>Over Pressure Alarm:</b> The Control Unit has detected excessive pressure in the air chamber. In order to prevent any possible harm to the person being treated, the unit will stop therapy. This is a Hard Error. The unit needs to be turned off and restarted.</p>	<ul style="list-style-type: none"> <li>• Turn the Control Unit off and back on.</li> <li>• Apply the same Wrap more tightly.</li> <li>• Apply a different Wrap.</li> </ul> <p>If the problem persists, call customer service at 1.888.GameReady (426.3732).</p>
 <p style="text-align: center;"><b>Hard Error</b></p>	<p><b>Pressure Too High Alarm:</b> The Control Unit has detected that the Wrap has not properly deflated. In order to prevent any possible harm to the person being treated, the unit will stop therapy. This is a Hard Error. The unit needs to be turned off and restarted.</p>	<p>This error often comes about when the person being treated moves around during treatment and puts pressure on the air bladder. If this is not the case try the following:</p> <ul style="list-style-type: none"> <li>• Turn the Control Unit off and back on.</li> <li>• Apply the same Wrap more tightly.</li> <li>• Apply a different Wrap.</li> </ul> <p>If the problem persists, call customer service at 1.888.GameReady (426.3732).</p>
 <p style="text-align: center;"><b>Hard Error</b></p>	<p><b>Low Flow Alarm:</b> The Control Unit has detected an interruption of fluid flow that it could not correct. In order to prevent possible damage to the fluid pump, the unit will stop therapy. This is a Hard Error. The unit needs to be turned off and restarted.</p>	<ul style="list-style-type: none"> <li>• Check the hose and Wrap for kinks that might cut off fluid flow.</li> <li>• Make sure there is water in the ice box.</li> <li>• Make sure that the ice box filter is clean.</li> <li>• Reapply the Wrap so that it is snug against the body part being treated.</li> </ul> <p>If the problem persists, call customer service at 1.888.GameReady (426.3732).</p>

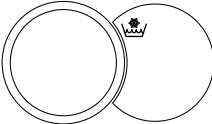
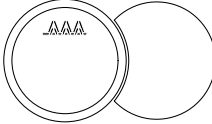
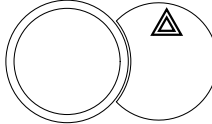
## TROUBLESHOOTING

ERROR SCREEN	WHAT DOES IT MEAN?	WHAT SHOULD I DO?
 <p style="text-align: center;"><b>Hard Error</b></p>	<p><b>Dry Pump Alarm:</b> The Control Unit has detected a dry pump. This error is displayed after one attempt to correct the problem has failed. In order to prevent possible damage to the fluid pump, the unit will stop therapy. This is a Hard Error. The unit needs to be turned off and restarted.</p>	<ul style="list-style-type: none"> <li>• Make sure there is water in the ice box.</li> <li>• Verify that the ice box filter is not clogged.</li> <li>• Turn the Control Unit off and on again.</li> <li>• Select “No Pressure” and run the system for 1 minute using the largest Wrap available, lying it on the floor or table next to the Control Unit (not on the body).</li> </ul> <p>If the problem persists, call customer service at 1.888.GameReady (426.3732).</p>
 <p style="text-align: center;"><b>Hard Error</b></p>	<p><b>Pressure Sensor Alarm:</b> The Control Unit has detected a problem calibrating the pneumatic compression circuit on startup. This is a Hard Error. The Unit needs to be turned off and restarted.</p>	<ul style="list-style-type: none"> <li>• Disconnect the Wrap from the Control Unit.</li> <li>• Turn the Control Unit off and on again without a Wrap connected.</li> </ul> <p style="text-align: center;">This should clear the error.</p> <p>If the problem persists, call customer service at 1.888.GameReady (426.3732).</p>
 <p style="text-align: center;"><b>Hard Error</b></p>	<p><b>Systems Error:</b> The Control Unit has determined that the fluid pump may be working too hard. This could be caused by ice or debris in the fluid circuit. In order to prevent possible damage to the fluid pump, the unit will stop therapy. This is a Hard Error. The unit needs to be turned off and restarted.</p>	<ul style="list-style-type: none"> <li>• Turn the Control Unit off and back on again.</li> <li>• Check the filter.</li> <li>• If that does not solve the problem turn the Control Unit off for 20 minutes before turning it on again to try again.</li> </ul> <p>If the problem persists, call customer service at 1.888.GameReady (426.3732).</p>
 <p style="text-align: center;"><b>Hard Error</b></p>	<p><b>Self-Test Error:</b> The Control Unit has detected an electronic problem at startup. This is a Hard Error. The unit needs to be turned off and restarted.</p>	<ul style="list-style-type: none"> <li>• Disconnect the Wrap from the Control Unit.</li> <li>• Turn the Control Unit off and on again without a Wrap connected.</li> </ul> <p>If the problem persists, call customer service at 1.888.GameReady (426.3732).</p>

## T R O U B L E S H O O T I N G

### **System will not turn on:**

Check that the AC adapter is securely plugged into a working electrical outlet.

### **Control Unit turns off during use:**

If the system current draw rises above 1.99 amps during operation, the Control Unit will shut off to prevent damage to the pumps. Usually this is an indicator of a blockage in the fluid or air flow. Check the Wrap and the Connector Hose to be sure there are no kinks, creases or folds. Unplug the Control Unit to reset the system, and try the Wrap again. If the Control Unit shuts off again, there is either a problem with the Wrap or the Control Unit. Try a different Wrap to determine if it is the Control Unit or the Wrap and call Game Ready customer service at 1.888.GameReady for further assistance.

### **Control unit leaks water when placed on its side:**

1. If the Control Unit is on its side, check to be sure that the control panel is not upside down. The unit is not designed to rest this way, and doing so will cause water to leak through its air vent. While a minimal amount of water leakage should not damage the system, immediately place the unit in its proper position: upright or on its side with the rubber feet facing down.
2. If there is excess water on the rubber gasket around the mouth of the ice box, the lid will not seal properly, and some of the water is likely to drip out when placed on its side. Simply wipe off excess water from the gasket and close the lid securely.
3. Check the ice box gasket to be sure it's seated properly around the lip of the ice box. If it is not flat in the groove, push it down so that it is flush with the lip of the ice box. If the gasket is damaged, call Game Ready customer service at 1.888.GameReady for further assistance.

## **WARRANTY: CONTROL UNIT**

CoolSystems warrants that the Game Ready Control Unit, if properly used, will be free from defects in material and workmanship for a period of one (1) year after the date the Game Ready Control Unit was purchased.

If the Game Ready Control Unit, which is the subject of this Limited Warranty, fails during the warranty period for reasons covered by this Limited Warranty, CoolSystems, at its options, will:

- REPAIR the Game Ready Control Unit OR
- REPLACE the Game Ready Control Unit with another Game Ready Control Unit.

THIS LIMITED WARRANTY AND ANY IMPLIED WARRANTIES THAT MAY EXIST UNDER STATE LAW APPLY ONLY TO THE ORIGINAL PURCHASER OF THE GAME READY CONTROL UNIT AND ARE NON-TRANSFERABLE.

### **Extent of Limited Warranty**

This limited warranty does not cover damages due to external causes, including, without limitation, accident, usage not in accordance with product instructions, misuse, neglect, alteration or repair.

### **How to Obtain Warranty Service**

To obtain warranty service call toll-free 1.888.GameReady You must have returned the Warranty Registration card to CoolSystems within thirty (30) days from the date of purchase to qualify for warranty service. If you qualify for warranty service from CoolSystems, you will be issued a Returned Material Authorization (RMA) number.

When you return the Game Ready Control Unit to CoolSystems, you must write the RMA number on the outside of the package. CoolSystems will not accept returned Game Ready Control Units without an RMA number on the package.

If you return the Game Ready Control Unit to CoolSystems, you must assume the risk of damage or loss during shipping. You must use the original packaging or the equivalent. CoolSystems may require you to verify in writing that you are the original purchaser of the Game Ready Control Unit. CoolSystems may elect to replace or repair the Game Ready Control Unit with either a new or reconditioned product. The returned product shall become CoolSystems' property upon receipt.

The replacement Game Ready Control Unit is warranted under this written warranty and is subject to the same limitations and exclusions for the remainder of the original warranty period. THIS WARRANTY IS NOT TRANSFERABLE.

### **WARRANTY LIMITATIONS AND EXCLUSIONS**

THESE WARRANTIES REPLACE ALL OTHER WARRANTIES, EXPRESS OR IMPLIED INCLUDING, BUT NOT LIMITED TO, THE IMPLIED WARRANTIES OF MERCHANTABILITY AND FITNESS FOR A PARTICULAR PURPOSE. COOLSYSTEMS MAKES NO EXPRESS WARRANTIES BEYOND THOSE STATED HERE. COOLSYSTEMS DISCLAIMS ALL OTHER WARRANTIES, EXPRESS OR IMPLIED INCLUDING, WITHOUT LIMITATION, IMPLIED WARRANTIES OF MERCHANTABILITY AND FITNESS FOR A PARTICULAR PURPOSE. SOME JURISDICTIONS DO NOT ALLOW THE EXCLUSION OF IMPLIED WARRANTIES SO THIS LIMITATION MAY NOT APPLY TO YOU.

ALL EXPRESS AND IMPLIED WARRANTIES ARE LIMITED IN DURATION TO THE LIMITED WARRANTY PERIOD. NO WARRANTIES APPLY AFTER THAT PERIOD. SOME JURISDICTIONS DO NOT ALLOW LIMITATIONS ON HOW LONG AN IMPLIED WARRANTY LASTS, SO THIS LIMITATION MAY NOT APPLY TO YOU.

### **LIMITATIONS OF LIABILITY**

COOLSYSTEMS' RESPONSIBILITY UNDER THIS, OR ANY OTHER WARRANTY, IMPLIED OR EXPRESS, IS LIMITED TO REPAIR OR REPLACEMENT, AS SET FORTH ABOVE. THESE REMEDIES ARE THE SOLE AND EXCLUSIVE REMEDIES FOR ANY BREACH OF WARRANTY. COOLSYSTEMS IS NOT RESPONSIBLE FOR DIRECT, SPECIAL, INCIDENTAL, OR CONSEQUENTIAL DAMAGES RESULTING FROM ANY BREACH OF WARRANTY OR UNDER ANY OTHER LEGAL THEORY INCLUDING, BUT NOT LIMITED TO, LOST PROFITS, DOWNTIME, GOODWILL, AND DAMAGE TO OR REPLACEMENT OF EQUIPMENT AND PROPERTY. SOME JURISDICTIONS DO NOT ALLOW THE EXCLUSION OR LIMITATION OF INCIDENTAL OR CONSEQUENTIAL DAMAGES, SO THE ABOVE LIMITATIONS OR EXCLUSIONS MAY NOT APPLY TO YOU.

THIS LIMITED WARRANTY GIVES YOU SPECIFIC RIGHTS, AND YOU MAY ALSO HAVE OTHER RIGHTS THAT VARY FROM JURISDICTION TO JURISDICTION.

### **How to Complete the Warranty Registration Card**

You will need the following information to complete your registration card:

The Control Unit's model number and its serial number.

These numbers are located on the label on the bottom of the Control Unit.

## USER REPLACEABLE ITEMS

The items listed below can be obtained by calling toll-free 1.888.GameReady

- Filter
- Ice Box Gasket
- Ice Box Lid Support Kit
  - Ice Box Lid Support-Left
  - Ice Box Lid Support-Right
  - 2x Ice Box Lid Support Nuts
  - 2x screws
  - 2x washers
  - 2x lock washers
- Ice Box Latch Kit
  - Ice Box Latch
  - Ice Box Latch Cup
  - 2x screws for Latch/Latch Cup
  - Ice Box Latch Cup Hook
  - 2x screws for Latch Cup Hook
- Rubber Foot (with adhesive)
- Handle Grip
- Screw Plug
- Knob

## POWER SUPPLY DISCLAIMER

Mains power quality should be that of a typical commercial or hospital environment. Surge protection is recommended to protect the Control Unit. If the user of the Game Ready System requires continued operation during power mains interruptions, it is recommended that the Game Ready System be powered from a uninterruptible power supply.

## PRODUCT SPECIFICATIONS

**Size:**

400mm width x132mm height x 210mm depth (15.75 in x 5.2 in. x 8.27 in.), not including carrying case.

**Weight:**

8lbs. empty, 18lbs, full of ice & water.

**Pressure level:**

Cycles from 5mm Hg up to 75mm Hg.

**AC power:**

120V/60 Hz or 240V/50 Hz

**DC input:**

12V/2.5 A

## HOW TO CONTACT US

GameReady  
Customer Service Department  
2201 Dwight Way  
Berkeley, CA 94704  
1.510.559.3940

Toll-free phone number:  
1.888.GameReady  
(1.888.426.3732)  
[www.gameready.com](http://www.gameready.com)